

LUMOTAST 25



1

LUMO
25

General data

LUMOTAST 25 pushbutton range

- Illuminable pushbuttons and signal lamps. Please order lamps/LEDs separately.
- Mounting hole diameter: 16.2 mm
- 42 V/100 mA max.
- Water-jet proof IP65
- Low profile
- Lamp socket Bi-Pin T 1 for LEDs and filament lamps
- Keyed socket connector and flat ribbon cable or PCB plug-in socket
- Ring nut or click fixing method.

Content

LUMOTAST 25 illuminated pushbutton

LUMOTAST 25 illuminated pushbutton with flush lens, „Click“ quick-assembly feature	1 - 22
LUMOTAST 25 illuminated pushbutton with flush lens, ring nut fixing	1 - 24
LUMOTAST 25 illuminated pushbutton with protruding lens, „Click“ quick-assembly feature	1 - 25
LUMOTAST 25 illuminated pushbutton with protruding lens, ring nut fixing	1 - 25
LUMOTAST 25 illuminated pushbutton with protruding collar, „Click“ quick-assembly feature	1 - 26
LUMOTAST 25 illuminated pushbutton with protruding collar, ring nut fixing	1 - 26

LUMOTAST 25 selector switch

LUMOTAST 25 selector switch, „Click“ quick-assembly feature	1 - 28
LUMOTAST 25 selector switch, ring nut fixing	1 - 29

LUMOTAST 25 keylock switch

LUMOTAST 25 keylock switch	1 - 30
	1 - 31

LUMOTAST 25 emergency stop pushbutton

LUMOTAST 25 emergency stop pushbutton, ring nut fixing	1 - 32
	1 - 33

LUMOTAST 25 signal lamp

LUMOTAST 25 signal lamp, 24 V, „Click“ quick-assembly feature	1 - 34
LUMOTAST 25 signal lamp, 24 V, ring nut fixing	1 - 36
	1 - 36

Series LUMOTAST 25

16.2 mm mounting hole diameter

1

Design Click-Version

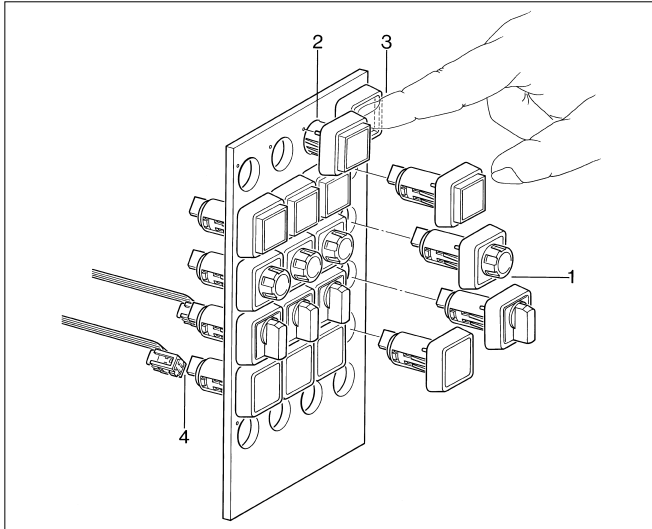

1. As delivered
2. Insert pushbutton in hole
3. Actuate once
4. Insert connector with flat-ribbon cable

LUMO
25

Disassembly Click-Version

Click-Version from front (only for pushbuttons and signal lamps with special tool for dismounting)

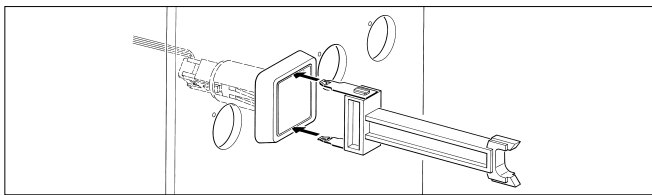

1. Grip body/lens

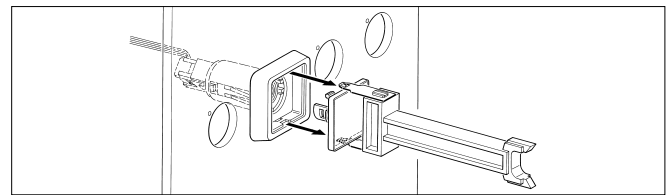

2. Pull out body/lens

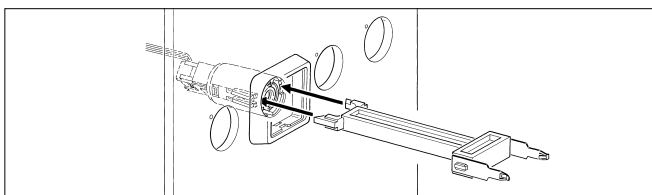

3. Release click lever

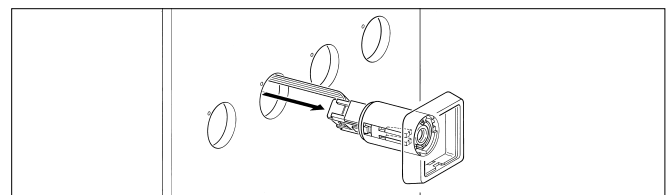

4. Pull out pushbutton/signal lamp with cable

LUMOTAST 25

Dimensional drawing

With quick connector and flat-ribbon cable

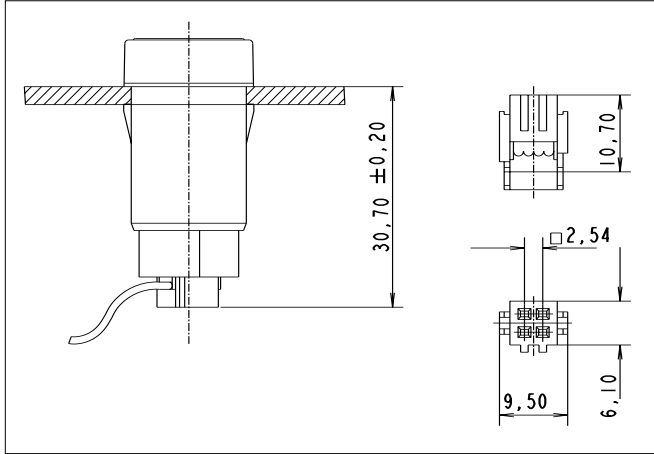

Connection diagram (PCB top view)

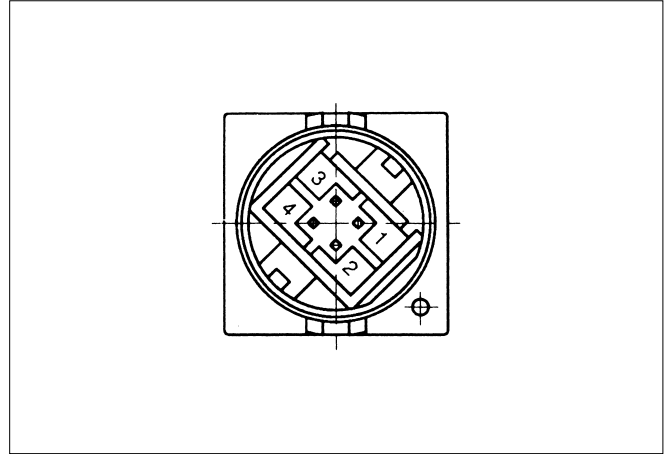

1 + 4 = pushbutton connection 2 + 3 = lamp connection

With plug-in socket

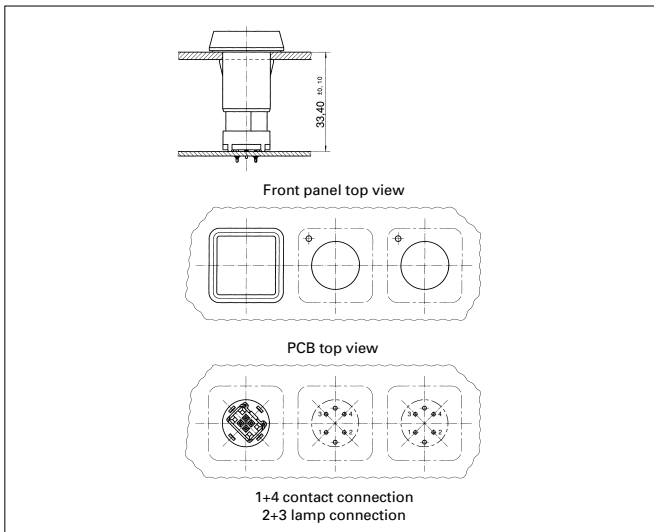

Plug-in socket for PCB

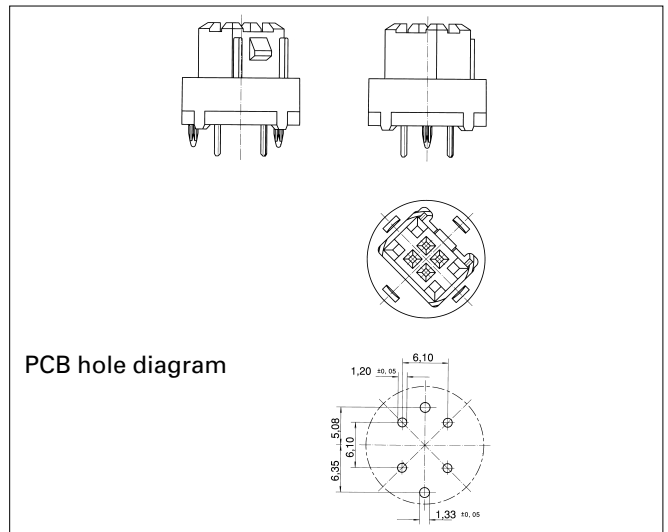

PCB hole diagram

LUMOTAST 25 illuminated pushbutton

Pict.: colourless



Pict.: blue

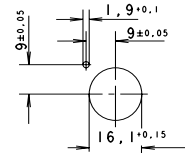

Panel cut-out

Technical dataLUMO
25**General information**

Form of lens	see order block
Colour of lens	see order block
Form of collar	square

Dimensions

Length of collar	25 mm
Width of collar	25 mm
Overall height	7.1 mm
Mounting depth with connector	30.7 mm
Mounting depth with plug-in socket	33.4 mm
Mounting hole	16.2 mm

Mechanical design

Mounting	see order block
Terminals	pin connector 4-pol./ plug-in socket
Contact system	snap-action contact
Contact function	momentary
Contact arrangement	1 NO
Contact materials	Au
Illuminability	yes
Lamp socket	Bi-Pin T 1/T 1¼

Mechanical characteristics

Operating force max.	6 N
Operating travel	3 mm
Switching travel	2 mm
Robustness min.	100 N



Electrical characteristics

Rated voltage AC/DC max.	42 V
Rated voltage AC/DC min.	0.02 V
Rated current AC/DC max.	100 mA
Rated current AC/DC min.	0.01 mA
Contact resistance max.	100 mΩ
Bouncing time max.	5 ms

Other specifications

Operating life (operations)	1000000
Degree of protection from front side	IP65
Ambient temp. operating without lamp min.	-25 °C
Ambient temp. operating without lamp max.	+70 °C
Ambient temp. operating with lamp min.	-25 °C
Ambient temp. operating with lamp max.	+55 °C
Storage temperature min.	-40 °C
Storage temperature max.	+80 °C
Resistance to constant environment	acc. to IEC 600 68-2-3 and 2-30
Resistance at variable environment	acc. to IEC 600 68-2-14 and 2-33
Weight	7 g

Accessories LUMOTAST 25 illuminated pushbutton

Description	Photo	Order no.	Page
Filament lamp, Bi-Pin T 1¼ base, 12 V		1.90.180.474/0000	5 - 5
Filament lamp, Bi-Pin T 1¼ base, 28 V		1.90.180.475/0000	5 - 5
LED Bi-Pin T 1 superbright, red, 24 V		1.90.690.351/0000	5 - 18

LUMOTAST 25

Accessories LUMOTAST 25 illuminated pushbutton

Description	Photo	Order no.	Page
LED Bi-Pin T 1 superbright, green, 24 V		1.90.690.352/0000	5 - 18
LED Bi-Pin T 1 superbright, yellow, 24 V		1.90.690.353/0000	5 - 18
LED Bi-Pin T 1 superbright, blue, 24 V		1.90.690.354/0000	5 - 18
LED Bi-Pin T 1 superbright, white, 24 V		1.90.690.355/0000	5 - 18
LED Bi-Pin T 1, red, 3 V		1.90.691.026/0000	5 - 17
LED Bi-Pin T 1, green, 3 V		1.90.691.027/0000	5 - 17
LED Bi-Pin T 1, yellow, 3 V		1.90.691.028/0000	5 - 17
Plug-in socket for PCB		5.00.645.036/0000	5 - 28
Cable (flat ribbon cable 10 cm with socket connector and male quick connector, AMP 4-pin)		5.03.771.306/0000	5 - 27
Disassembly tool for LUMOTAST 25, RAFIX 16		5.05.800.042/0000	5 - 26
Blanking cap complete with sealing disc and ring nut, square		5.05.800.049/0100	5 - 33
Label holder, flush, for square collar		5.07.620.004/0000	2 - 76
Flat ribbon cable, 4-wire, 1 m long		5.37.700.124/0000	5 - 27
Fixing spanner M 15, M 16		5.58.002.019/0105	5 - 25
Legend insert for illuminated versions		5.70.635.000/2000	
Legend label 23 x 16 for label holder, without legend		5.73.111.000/0000	2 - 76
Socket connector, 4-pin		5.92.025.368/0000	5 - 26

1

LUMO
25

1

LUMOTAST 25 illuminated pushbutton with flush lens, "Click" quick-assembly feature

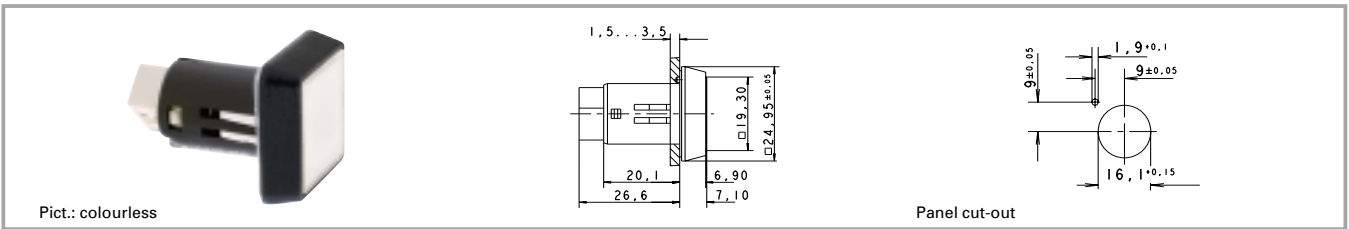

Contact function	Contact arrangement	Colour of lens	Order no. complete	Order no. single parts	
				Housing	Lens
momentary	1 NO	transparent colourless	1.15.150.006/1002	1.15.150.506/0000	5.49.077.011/1002
momentary	1 NO	transparent red	1.15.150.006/1306	1.15.150.506/0000	5.49.077.011/1306
momentary	1 NO	transparent yellow	1.15.150.006/1403	1.15.150.506/0000	5.49.077.011/1403
momentary	1 NO	transparent green	1.15.150.006/1505	1.15.150.506/0000	5.49.077.011/1505
momentary	1 NO	transparent blue	1.15.150.006/1607	1.15.150.506/0000	5.49.077.011/1607

Technical data see page 1 - 22

Accessories:

Legend insert for illuminated versions: 5.70.635.000/2000

Note when using LEDs: A notch on the lamp socket identifies the cathode side.

LUMO
25

LUMOTAST 25 illuminated pushbutton with flush lens, ring nut fixing

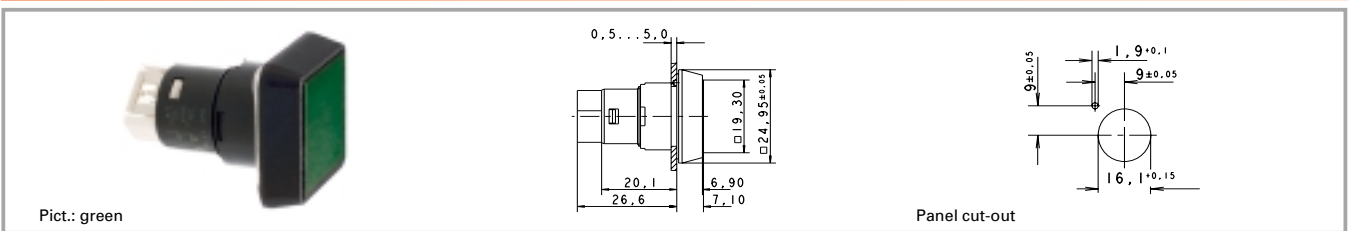

Contact function	Contact arrangement	Colour of lens	Order no. complete	Order no. single parts	
				Housing	Lens
momentary	1 NO	transparent colourless	1.15.150.056/1002	1.15.150.556/0000	5.49.077.011/1002
momentary	1 NO	transparent red	1.15.150.056/1306	1.15.150.556/0000	5.49.077.011/1306
momentary	1 NO	transparent yellow	1.15.150.056/1403	1.15.150.556/0000	5.49.077.011/1403
momentary	1 NO	transparent green	1.15.150.056/1505	1.15.150.556/0000	5.49.077.011/1505
momentary	1 NO	transparent blue	1.15.150.056/1607	1.15.150.556/0000	5.49.077.011/1607

Technical data see page 1 - 22

Accessories:

Legend insert for illuminated versions: 5.70.635.000/2000

Note when using LEDs: A notch on the lamp socket identifies the cathode side.

LUMOTAST 25

LUMOTAST 25 illuminated pushbutton with protruding lens, "Click" quick-assembly feature

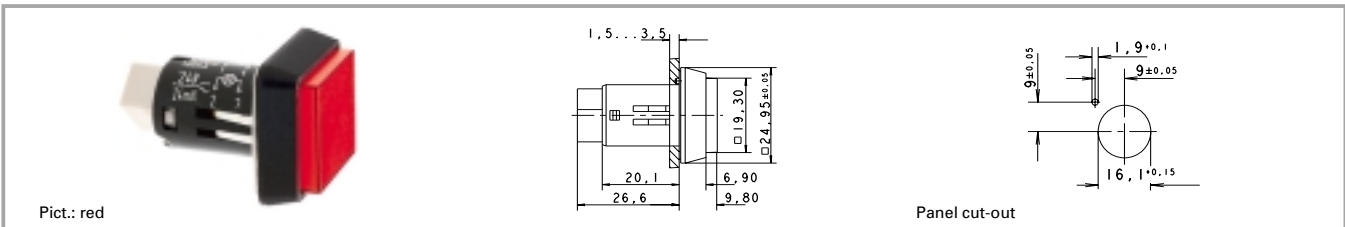

Contact function	Contact arrangement	Colour of lens	Order no. complete	Order no. single parts	
				Housing	Lens
momentary	1 NO	transparent colourless	1.15.150.106/1002	1.15.150.606/0000	5.49.077.012/1002
momentary	1 NO	transparent red	1.15.150.106/1306	1.15.150.606/0000	5.49.077.012/1306
momentary	1 NO	transparent yellow	1.15.150.106/1403	1.15.150.606/0000	5.49.077.012/1403
momentary	1 NO	transparent green	1.15.150.106/1505	1.15.150.606/0000	5.49.077.012/1505
momentary	1 NO	transparent blue	1.15.150.106/1607	1.15.150.606/0000	5.49.077.012/1607

Technical data see page 1 - 22

Accessories:

Legend insert for illuminated versions: 5.70.635.000/2000

Note when using LEDs: A notch on the lamp socket identifies the cathode side.

LUMOTAST 25 illuminated pushbutton with protruding lens, ring nut fixing

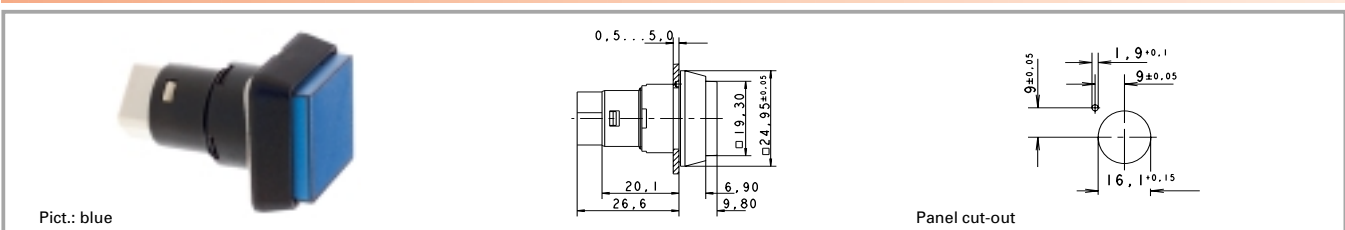

Contact function	Contact arrangement	Colour of lens	Order no. complete	Order no. single parts	
				Housing	Lens
momentary	1 NO	transparent colourless	1.15.150.156/1002	1.15.150.656/0000	5.49.077.012/1002
momentary	1 NO	transparent red	1.15.150.156/1306	1.15.150.656/0000	5.49.077.012/1306
momentary	1 NO	transparent yellow	1.15.150.156/1403	1.15.150.656/0000	5.49.077.012/1403
momentary	1 NO	transparent green	1.15.150.156/1505	1.15.150.656/0000	5.49.077.012/1505
momentary	1 NO	transparent blue	1.15.150.156/1607	1.15.150.656/0000	5.49.077.012/1607

Technical data see page 1 - 22

Accessories:

Legend insert for illuminated versions: 5.70.635.000/2000

Note when using LEDs: A notch on the lamp socket identifies the cathode side.

1
LUMO
25

1

LUMOTAST 25 illuminated pushbutton with protruding collar, "Click" quick-assembly feature

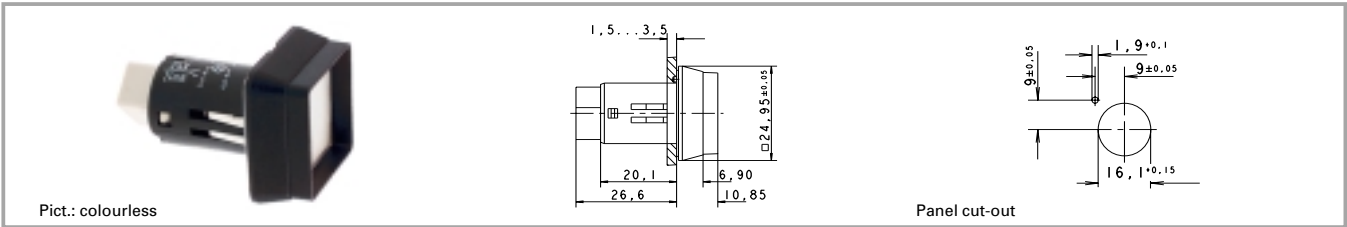

Contact function	Contact arrangement	Colour of lens	Order no. complete	Order no. single parts	
				Housing	Lens
momentary	1 NO	transparent colourless	1.15.150.206/1002	1.15.150.706/0000	5.49.077.011/1002
momentary	1 NO	transparent red	1.15.150.206/1306	1.15.150.706/0000	5.49.077.011/1306
momentary	1 NO	transparent yellow	1.15.150.206/1403	1.15.150.706/0000	5.49.077.011/1403
momentary	1 NO	transparent green	1.15.150.206/1505	1.15.150.706/0000	5.49.077.011/1505
momentary	1 NO	transparent blue	1.15.150.206/1607	1.15.150.706/0000	5.49.077.011/1607

Technical data see page 1 - 22

Accessories:

Legend insert for illuminated versions: 5.70.635.000/2000

Note when using LEDs: A notch on the lamp socket identifies the cathode side.

LUMO
25

LUMOTAST 25 illuminated pushbutton with protruding collar, ring nut fixing

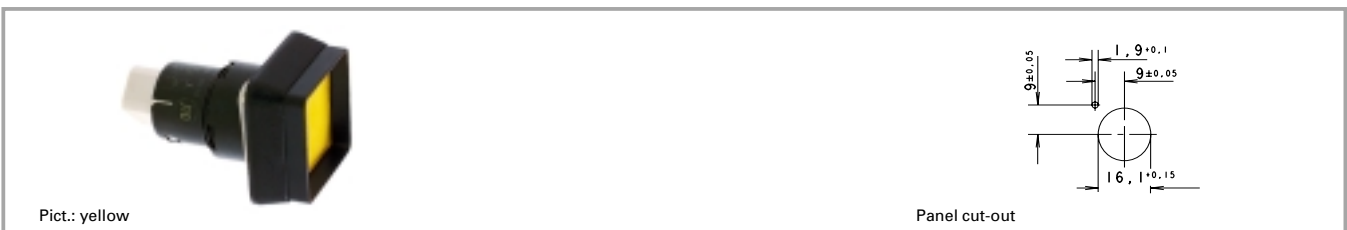

Contact function	Contact arrangement	Colour of lens	Order no. complete	Order no. single parts	
				Housing	Lens
momentary	1 NO	transparent colourless	1.15.150.256/1002	1.15.150.756/0000	5.49.077.011/1002
momentary	1 NO	transparent red	1.15.150.256/1306	1.15.150.756/0000	5.49.077.011/1306
momentary	1 NO	transparent yellow	1.15.150.256/1403	1.15.150.756/0000	5.49.077.011/1403
momentary	1 NO	transparent green	1.15.150.256/1505	1.15.150.756/0000	5.49.077.011/1505
momentary	1 NO	transparent blue	1.15.150.256/1607	1.15.150.756/0000	5.49.077.011/1607

Technical data see page 1 - 22

Accessories:

Legend insert for illuminated versions: 5.70.635.000/2000

Note when using LEDs: A notch on the lamp socket identifies the cathode side.

LUMOTAST 25 selector switch**Technical data**LUMO
25**General information**

Form of lens	handle
Colour of handle	black opaque
Form of collar	square

Dimensions

Length of collar	25 mm
Width of collar	25 mm
Overall height	17 mm
Mounting depth with connector	30.7 mm
Mounting depth with plug-in socket	33.4 mm
Mounting hole	16.2 mm

Mechanical design

Mounting	see order block
Terminals	pin connector 4-pol./ plug-in socket
Contact system	snap-action contact
Contact function	see order block
Contact arrangement	1 NO
Contact materials	Au
Illuminability	no

Mechanical characteristics

Operating force min.	0.03 Nm
Rotating angle	see order block
Robustness max.	1.5 Nm

Electrical characteristics

Rated voltage AC/DC max.	42 V
Rated voltage AC/DC min.	0.02 V
Rated current AC/DC max.	100 mA
Rated current AC/DC min.	0.01 mA
Contact resistance max.	100 mΩ
Bouncing time max.	5 ms

Other specifications



Operating life (operations)	500000
Degree of protection from front side	IP65
Ambient temp. operating min.	-25 °C
Ambient temp. operating max.	+70 °C
Storage temperature min.	-40 °C
Storage temperature max.	+80 °C
Resistance to constant environment	according to IEC 600 68-2-3 and 2-30
Resistance at variable environment	according to IEC 600 68-2-14 and 2-33
Weight	8 g

Accessories LUMOTAST 25 selector switch

Description	Photo	Order no.	Page
Plug-in socket for PCB		5.00.645.036/0000	5 - 28
Cable (flat ribbon cable 10 cm with socket connector and male quick connector, AMP 4-pin)		5.03.771.306/0000	5 - 27
Blanking cap complete with sealing disc and ring nut, square		5.05.800.049/0100	5 - 33
Label holder, flush, for square collar		5.07.620.004/0000	2 - 76

LUMOTAST 25

Accessories LUMOTAST 25 selector switch

Description	Photo	Order no.	Page
Flat ribbon cable, 4-wire, 1 m long		5.37.700.124/0000	5 - 27
Fixing spanner M 15, M 16		5.58.002.019/0105	5 - 25
Socket connector, 4-pin		5.92.025.368/0000	5 - 26

LUMOTAST 25 selector switch, "Click" quick-assembly feature

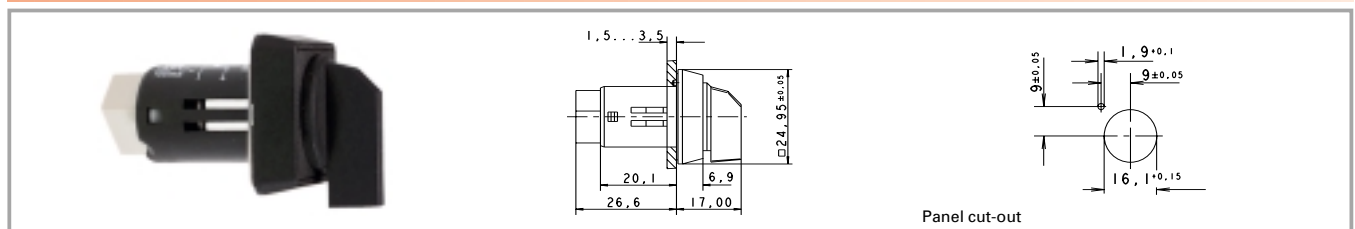

Contact arrangement	Contact function	Rotating angle	Form of lens	Order no. complete
1 NO	latching	right, 1 x 90°	 handle	1.15.153.100/0100

Technical data see page 1 - 28

LUMOTAST 25 selector switch, ring nut fixing

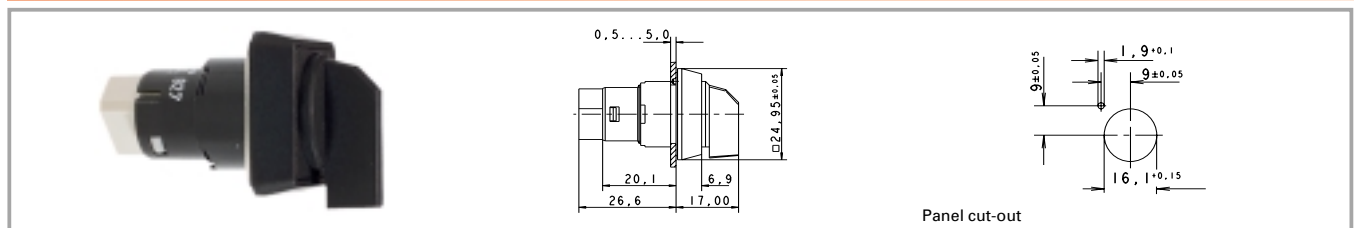

Contact arrangement	Contact function	Rotating angle	Form of lens	Order no. complete
1 NO	latching	right, 1 x 90°	 handle	1.15.153.106/0100

Technical data see page 1 - 28

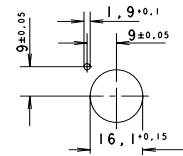
LUMOTAST 25 keylock switch

Panel cut-out

Technical dataLUMO
25**General information**

Colour of lens	black opaque
Form of collar	square

Dimensions

Length of collar	25 mm
Width of collar	25 mm
Overall height	32.3 mm
Mounting depth with connector	30.7 mm
Mounting depth with plug-in socket	33.4 mm
Mounting hole	16.2 mm

Mechanical design

Mounting	ring nut
Terminals	pin connector 4-pol./ plug-in socket
Contact system	snap-action contact
Contact function	latching
Contact arrangement	1 NO
Contact materials	Au
Illuminability	no
Lamp socket	no
Lock	cylinder lock
Wafers	8 pins
Lock type	5201
Number of locking positions	10000
Main key	yes
Symmetric key	yes
Key removal position	see order block

Mechanical characteristics

Operating force max.	1.5 Nm
Rotating angle	90°

Electrical characteristics

Rated voltage AC/DC max.	42 V
Rated voltage AC/DC min.	0.02 V
Rated current AC/DC max.	100 mA
Rated current AC/DC min.	0.01 mA
Contact resistance max.	100 mΩ
Bouncing time max.	5 ms

Other specifications

Operating life (operations)	50000
Degree of protection from front side	IP65
Ambient temp. operating min.	-25 °C
Ambient temp. operating max.	+70 °C
Storage temperature min.	-40 °C
Storage temperature max.	+80 °C
Resistance to constant environment	according to IEC 600 68-2-3 and 2-30
Resistance at variable environment	according to IEC 600 68-2-14 and 2-33
Weight	20 g

Accessories LUMOTAST 25 keylock switch

Description	Photo	Order no.	Page
Plug-in socket for PCB		5.00.645.036/0000	5 - 28
Cable (flat ribbon cable 10 cm with socket connector and male quick connector, AMP 4-pin)		5.03.771.306/0000	5 - 27
Blanking cap complete with sealing disc and ring nut, square		5.05.800.049/0100	5 - 33

LUMOTAST 25

Accessories LUMOTAST 25 keylock switch

Description	Photo	Order no.	Page
Label holder, flush, for square collar		5.07.620.004/0000	2 - 76
Flat ribbon cable, 4-wire, 1 m long		5.37.700.124/0000	5 - 27
Fixing spanner M 15, M 16		5.58.002.019/0105	5 - 25
Spare key		5.58.015.201/0000	
Legend label 23 x 16 for label holder, without legend		5.73.111.000/0000	2 - 76
Socket connector, 4-pin		5.92.025.368/0000	5 - 26

1

LUMO
25

LUMOTAST 25 keylock switch

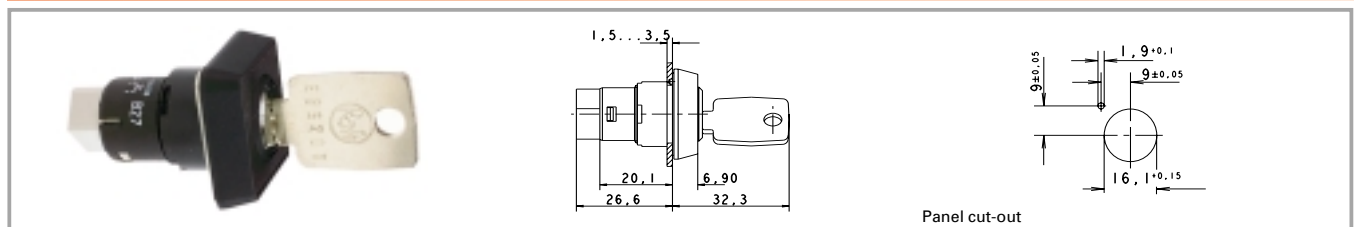

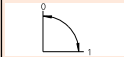
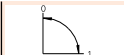
Contact arrangement	Contact function	Rotating angle	Key removal position	Colour of lens	Order no. complete
1 NO	latching	90°		black opaque	1.15.156.001/0000
1 NO	latching	90°		black opaque	1.15.156.011/0000

Technical data see page 1 - 30

Included: 2 keys.

LUMOTAST 25 emergency stop pushbutton**Technical data**LUMO
25**General information**

Colour of lens	opaque red
Form of collar	square
Colour of collar	see order block

Dimensions

Length of collar	25 mm
Width of collar	25 mm
Overall height	18.5 mm
Mounting depth with connector	30.7 mm
Mounting depth with plug-in socket	33.4 mm
Mounting hole	16.2 mm

Mechanical design

Mounting	ring nut
Terminals	pin connector 4-pol./ plug-in socket
Contact system	snap-action contact
Contact function	latching
Contact arrangement	2 NC (forcibly actuated)
Contact materials	Au
Illuminability	no

Mechanical characteristics

Operating force max.	10 N
Operating travel	2.6 mm
Switching travel	2 mm
Robustness min.	100 N

Electrical characteristics

Rated voltage AC/DC max.	25 V
Rated voltage AC/DC min.	0.02 V
Rated current AC/DC max.	1 A, 100 mA rated current
Rated current AC/DC min.	0.01 mA
Contact resistance max.	100 mΩ
Bouncing time max.	10 ms

Other specifications





Operating life	15000
Degree of protection from front side	IP65
Ambient temp. operating min.	-25 °C
Ambient temp. operating max.	+70 °C
Storage temperature min.	-40 °C
Storage temperature max.	+80 °C
Resistance to constant environment	according to IEC 600 68-2-3 and 2-30
Resistance at variable environment	according to IEC 600 68-2-14 and 2-33
Weight	9 g
Approvals	TÜV/UL according to EN 60947-5-5 and -5-1/A2, UL 508

Accessories LUMOTAST 25 emergency stop pushbutton

Description	Photo	Order no.	Page
Plug-in socket for PCB		5.00.645.036/0000	5 - 28
Cable (flat ribbon cable 10 cm with socket connector and male quick connector, AMP 4-pin)		5.03.771.306/0000	5 - 27
Blanking cap complete with sealing disc and ring nut, square		5.05.800.049/0100	5 - 33
Label holder, flush, for square collar		5.07.620.004/0000	2 - 76

LUMOTAST 25

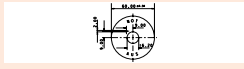
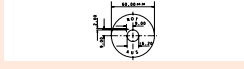
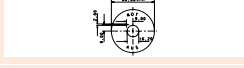
Accessories LUMOTAST 25 emergency stop pushbutton

Description	Photo	Order no.	Page
Flat ribbon cable, 4-wire, 1 m long		5.37.700.124/0000	5 - 27
Fixing spanner M 15, M 16		5.58.002.019/0105	5 - 25
Legend label 23 x 16 for label holder, without legend		5.73.111.000/0000	2 - 76
Emergency stop label, yellow, adhesive, round 60 mm, without legend		5.76.204.425/0400	
Emergency stop label, yellow, adhesive, round 60 mm, with legend "NOT-AUS"		5.76.204.426/0400	
Emergency stop label, yellow, adhesive, round 60 mm, with legend "ARRET-D'URGENCE"		5.76.204.427/0400	
Emergency stop label, yellow, adhesive, round 60 mm, with legend "EMERGENCY-STOP"		5.76.204.428/0400	
Emergency stop label, yellow, adhesive, round 60 mm, with legend "ARRESTO-D'EMERGENZA"		5.76.204.429/0400	
Socket connector, 4-pin		5.92.025.368/0000	5 - 26

1

LUMO
25

LUMOTAST 25 emergency stop pushbutton, ring nut fixing

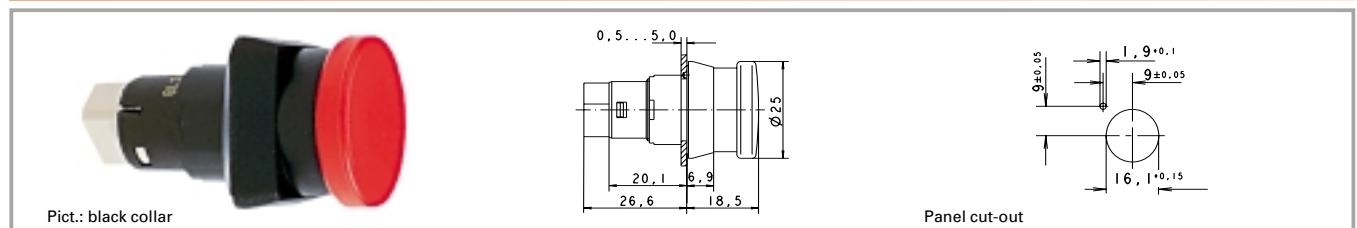

Contact function	Contact arrangement	Colour of collar	Order no. complete	Order no. single parts	
				Housing	Lens
latching	2 NC (forcibly actuated)	black	1.15.154.006/0301		
latching	2 NC (forcibly actuated)	yellow	1.15.154.016/0301		

Technical data see page 1 - 32

LUMOTAST 25 signal lamp

Pict.: red

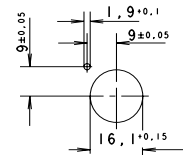

Panel cut-out

Technical dataLUMO
25**General information**

Form of lens	square
Colour of lens	see order block

Dimensions

Length of collar	25 mm
Width of collar	25 mm
Overall height	9.8 mm
Mounting depth with connector	30.7 mm
Mounting depth with plug-in socket	33.4 mm
Mounting hole	16.2 mm

Mechanical design

Mounting	see order block
Terminals	pin connector 4-pol./ plug-in socket
Lamp socket	Bi-Pin T 1/T 1¼
Lamp	filament lamp/LED

Electrical characteristics

Voltage limit max.	24 V
Power limit max.	0,7 W

Other specifications



Degree of protection from front side	IP65
Weight	7 g
Ambient temp. operating min.	-25 °C
Ambient temp. operating max.	+70 °C
Storage temperature min.	-40 °C
Storage temperature max.	+80 °C

Accessories LUMOTAST 25 signal lamp

Description	Photo	Order no.	Page
Filament lamp, Bi-Pin T 1¼ base, 12 V		1.90.180.474/0000	5 - 5
Filament lamp, Bi-Pin T 1¼ base, 28 V		1.90.180.475/0000	5 - 5
LED Bi-Pin T 1 superbright, red, 24 V		1.90.690.351/0000	5 - 18
LED Bi-Pin T 1 superbright, green, 24 V		1.90.690.352/0000	5 - 18
LED Bi-Pin T 1 superbright, yellow, 24 V		1.90.690.353/0000	5 - 18
LED Bi-Pin T 1 superbright, blue, 24 V		1.90.690.354/0000	5 - 18
LED Bi-Pin T 1 superbright, white, 24 V		1.90.690.355/0000	5 - 18
LED Bi-Pin T 1, red, 3 V		1.90.691.026/0000	5 - 17

LUMOTAST 25

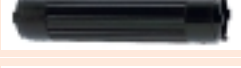
Accessories LUMOTAST 25 signal lamp

Description	Photo	Order no.	Page
LED Bi-Pin T 1, green, 3 V		1.90.691.027/0000	5 - 17
LED Bi-Pin T 1, yellow, 3 V		1.90.691.028/0000	5 - 17
Plug-in socket for PCB		5.00.645.036/0000	5 - 28
Cable (flat ribbon cable 10 cm with socket connector and male quick connector, AMP 4-pin)		5.03.771.306/0000	5 - 27
Disassembly tool for LUMOTAST 25, RAFIX 16		5.05.800.042/0000	5 - 26
Blanking cap complete with sealing disc and ring nut, square		5.05.800.049/0100	5 - 33
Label holder, flush, for square collar		5.07.620.004/0000	2 - 76
Flat ribbon cable, 4-wire, 1 m long		5.37.700.124/0000	5 - 27
Fixing spanner M 15, M 16		5.58.002.019/0105	5 - 25
Legend insert for illuminated versions		5.70.635.000/2000	
Legend label 23 x 16 for label holder, without legend		5.73.111.000/0000	2 - 76
Socket connector, 4-pin		5.92.025.368/0000	5 - 26

1

LUMO
25

LUMOTAST 25 signal lamp, 24 V, „Click“ quick-assembly feature

Pict.: red

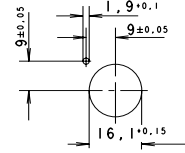
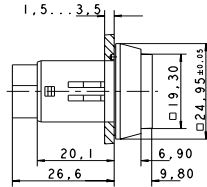

Panel cut-out

Voltage limit max.	Power limit max.	Lamp socket	Colour of lens	Order no. complete	Order no. single parts	
					Housing	Lens
24 V	0.7 W	Bi-Pin T 1/T 1 ¹ / ₄	transparent colourless	1.65.122.006/1002	1.65.122.906/0000	5.49.077.014/1002
24 V	0.7 W	Bi-Pin T 1/T 1 ¹ / ₄	transparent red	1.65.122.006/1306	1.65.122.906/0000	5.49.077.014/1306
24 V	0.7 W	Bi-Pin T 1/T 1 ¹ / ₄	transparent yellow	1.65.122.006/1403	1.65.122.906/0000	5.49.077.014/1403
24 V	0.7 W	Bi-Pin T 1/T 1 ¹ / ₄	transparent green	1.65.122.006/1505	1.65.122.906/0000	5.49.077.014/1505
24 V	0.7 W	Bi-Pin T 1/T 1 ¹ / ₄	transparent blue	1.65.122.006/1607	1.65.122.906/0000	5.49.077.014/1607

Technical data see page 1 - 34

Accessories:

Legend insert for illuminated versions: 5.70.635.000/2000

Do not press in lens in disassembled condition. Note when using a LED: A notch on the lamp identifies the cathode side.

LUMOTAST 25 signal lamp, 24 V, ring nut fixing

Pict.: blue

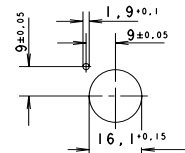
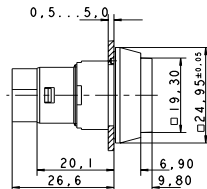

Panel cut-out

Voltage limit max.	Power limit max.	Lamp socket	Colour of lens	Order no. complete	Order no. single parts	
					Housing	Lens
24 V	0.7 W	Bi-Pin T 1/T 1 ¹ / ₄	transparent colourless	1.65.122.056/1002	1.65.122.956/0000	5.49.077.014/1002
24 V	0.7 W	Bi-Pin T 1/T 1 ¹ / ₄	transparent red	1.65.122.056/1306	1.65.122.956/0000	5.49.077.014/1306
24 V	0.7 W	Bi-Pin T 1/T 1 ¹ / ₄	transparent yellow	1.65.122.056/1403	1.65.122.956/0000	5.49.077.014/1403
24 V	0.7 W	Bi-Pin T 1/T 1 ¹ / ₄	transparent green	1.65.122.056/1505	1.65.122.956/0000	5.49.077.014/1505
24 V	0.7 W	Bi-Pin T 1/T 1 ¹ / ₄	transparent blue	1.65.122.056/1607	1.65.122.956/0000	5.49.077.014/1607

Technical data see page 1 - 34

Accessories:

Legend insert for illuminated versions: 5.70.635.000/2000

Do not press in lens in disassembled condition. Note when using LED: A notch on the lamp socket identifies the cathode side.