

## *Electrical Multimeter*

### *Instruction Sheet*

#### **Safety Information**

A **Warning** statement identifies hazardous conditions and actions that could cause bodily harm or death.







A **Caution** statement identifies conditions and actions that could damage the Meter or the equipment under test.

**To avoid possible electric shock or personal injury, follow these guidelines:**

- **Use the Meter only as specified in this instruction sheet or the protection provided by the Meter might be impaired.**
- **Do not use the Meter or test leads if they appear damaged, or if the Meter is not operating properly.**
- **Always use proper terminals, switch position, and range for measurements.**
- **Verify the Meter's operation by measuring a known voltage. If in doubt, have the Meter serviced.**
- **Do not apply more than the rated voltage, as marked on Meter, between terminals or between any terminal and earth ground.**
- **Use caution with voltages above 30 V ac rms, 42 V ac peak, or 60 V dc. These voltages pose a shock hazard.**
- **Disconnect circuit power and discharge all high-voltage capacitors before testing resistance, continuity, diodes, or capacitance.**

- **Do not use the Meter around explosive gas, vapor or in wet environments.**
- **When using test leads or probes, keep your fingers behind the finger guards.**
- **Only use test leads that have the same voltage, category, and amperage ratings as the meter and that have been approved by a safety agency.**
- **Remove test leads from Meter before opening the battery door or Meter case.**
- **Comply with local and national safety requirements when working in hazardous locations.**
- **Use proper protective equipment, as required by local or national authorities when working in hazardous areas.**
- **Avoid working alone.**
- **Check the test leads for continuity before use. Do not use if the readings are high or noisy.**

## Symbols

	Earth ground		Double Insulated
	Hazardous voltage		Hazardous voltage
	Battery (Low battery when shown on the display.)		Important Information; Refer to manual
CAT III	IEC Measurement Category III – CAT III equipment is designed to protect against transients in equipment in fixed equipment installations, such as distribution panels, feeders and short branch circuits, and lighting systems in large buildings.	CAT IV	IEC Measurement Category IV – CAT IV equipment is designed to protect against transients from the primary supply level, such as an electricity meter, overhead or underground utility service.
	Do not dispose of this product as unsorted municipal waste. Go to Fluke's website for recycle information.		

## Terminals

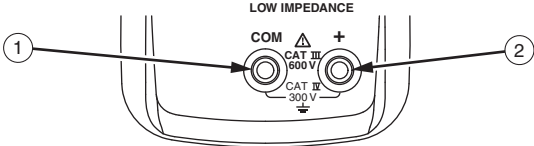
	
fda09.eps	
No.	Description
①	Common (return) terminal for all measurements.
②	Input terminal for all measurements.

## ***Automatic Range Selection***

The meter defaults to autoranging when turned on. To return to autoranging while in the manual range mode, press **RANGE** for 1 second.

## ***Manual Range Selection (@ CHEK, $\Omega$ and $\nabla$ )***

See each function in this instruction sheet for available ranges.

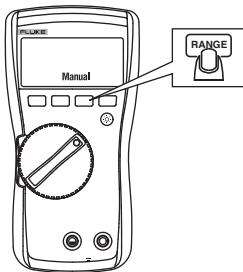

## **Battery Saver™ (Sleep Mode)**

If the Meter is ON, but inactive and not connected to voltage for more than 20 minutes, the display goes blank to preserve battery life. To resume operation, press any button or turn the rotary switch. To disable the Sleep Mode, refer to the Power-Up Options section.

Sleep Mode is always disabled in MIN/MAX record mode.

## **Backlight**



Press  to toggle the backlight on and off. The backlight automatically turns off after 40 seconds. To disable backlight auto-off, refer to the Power-Up Options section.

## **Display Hold**

### **Warning**





**To avoid electric shock, when Display HOLD is activated, be aware that the display will not change when you apply a different voltage.**

In the Display HOLD mode, the Meter freezes the digital display.

1. Press  to activate Display HOLD. (**HOLD** is displayed.)
2. To exit and return to normal operation, press  or turn the rotary switch.

## Power-Up Options

To select a Power-Up Option, hold down the button indicated in the following table while turning the Meter from off to the  CHECK function. Power-Up Options are canceled when you turn the Meter off and when sleep mode is activated.

Button	Power-Up Options
	Turns on all display segments until the button is released.
	Disables beeper. bEEP is displayed when enabled.
	Turns on all display segments until the button is released.
	Disables Sleep mode. P <sub>o</sub> FF is displayed when enabled.
	Disables auto backlight off. L <sub>o</sub> FF is displayed when enabled.

## **⚠️** **⚡** **CHEK**

If a dc or ac voltage greater than about 3 V is present across the inputs when the meter is set to **⚡** CHEK, the meter switches automatically to dc or ac voltage mode and displays the voltage.

When **⚡** CHEK is activated, the meter has low input impedance (LoZ)  $\approx 3 \text{ k}\Omega$ . This load can alter the voltages in electronic control circuits. Do not use **⚡** CHEK to measure voltage in circuits that could be damaged by a  $3 \text{ k}\Omega$  load.

### *Note*

***⚡** CHEK can be effectively used to eliminate “ghost” voltages.*

## **AC and DC Voltage**

Also refer to **⚡** Chek.

### **Volts**

**Input Impedance  $\approx 3 \text{ k}\Omega$**

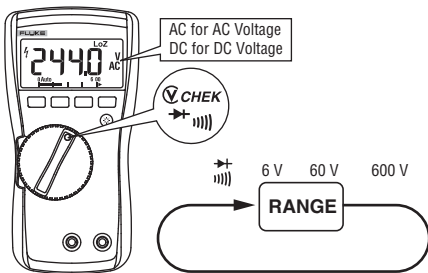

## Diode Test ➔

Turn off circuit power before testing. For best results, diodes should be measured out of circuit.

Also refer to  CHEK.

### Good Diode

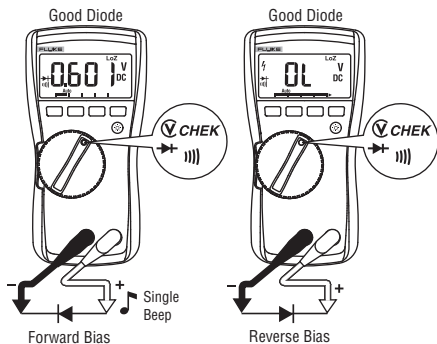

fda03.eps

### Bad Diode

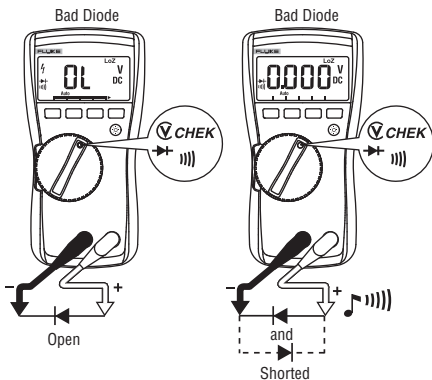

fda04.eps



## Continuity

Turn off circuit power before testing.

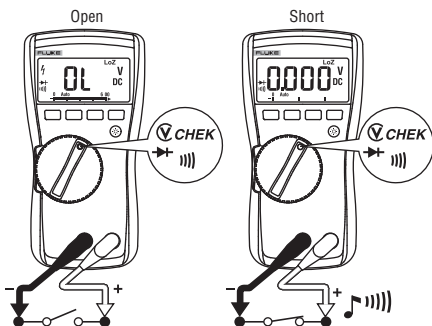

fda05.eps

## Continuity Capture

Turn off circuit power before testing.

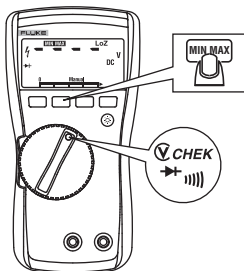

fda06.eps

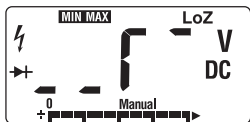
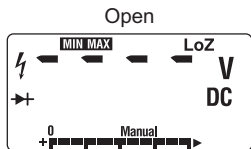
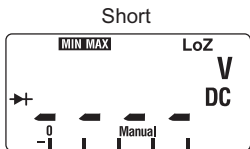

Short to Open

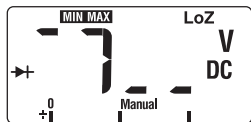

Open to Short

fda10.eps

Captures transitions longer than  $500 \mu\text{s}$  ( $1/2000^{\text{th}}$  of a second).

Transitions after the first transition cause the Meter to beep, but the display does not change.

To reset the display to the current condition, press **MIN MAX** .

To exit, press **MIN MAX** for 2 seconds, or turn the rotary switch.

## Resistance $\Omega$

Turn off circuit power before testing.

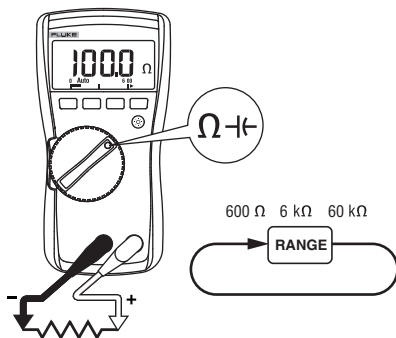

fda07.eps

## Capacitance $\mu\text{F}$

Turn off circuit power, then disconnect and discharge the capacitor before measuring capacitance.

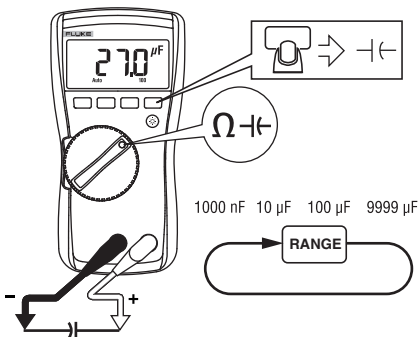

fda08.eps

Note correct probe polarity for polarized capacitors.



## Disabling the Beeper

To disable the beeper for all modes, hold down **MIN MAX** for 2 seconds while turning the meter on to  $\checkmark$  Chek.

## Maintenance

Wipe the case with a damp cloth and mild detergent. **Do not use abrasives, isopropyl alcohol, or solvents to clean the case or lens/window.** Dirt or moisture in the terminals can affect readings.

## Battery Replacement

Remove the test leads before disassembling the case.

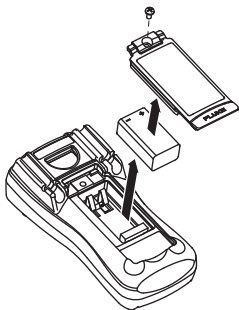

eeo11f.eps

## Replacement Parts

Fluke TL-75 (Double-insulated leads)

PN 855705

Fluke 113 Instruction sheet

PN 3083192

## Service and Parts

This meter should be serviced only by a qualified service technician. To locate an authorized service center, call:

USA: 1-888-99-FLUKE (1-888-993-5853)

Canada: 1-800-36-FLUKE (1-800-363-5853)

Europe: +31 402-675-200

Japan: +81-3-3434-0181

Singapore: +65-738-5655

Anywhere in the world: +1-425-446-5500

Or, visit Fluke's Web site at [www.fluke.com](http://www.fluke.com).

## Specifications

Accuracy is specified for 1 year after calibration, at operating temperatures of 18 °C to 28 °C, with relative humidity at 0 % to 95 %. Accuracy specifications are given as follows:

### Note

*Specifications are subject to change without notice.*

$\pm$ ([% of reading] + [number of least significant digits])

Function	Range	Resolution	Accuracy	
			DC, 45 to 500 Hz	500 Hz to 1 kHz
Ⓞ Chek <sup>[1,2]</sup>	6.000 V 60.00 V 600.0 V	0.001 V 0.01 V 0.1 V	2.0 % +3	4.0 % + 3
Function	Range	Resolution	Accuracy	
→ <sup>[3]</sup>	2.000V	0.001V	2.0 % + 3	
))) <sup>[3]</sup>			Beeper on <20 Ω, off >250 Ω; detects opens or shorts of 500 μs or longer	
Ω <sup>[3]</sup>	600.0 Ω	0.1 Ω	0.9 % + 2	
	6.000 kΩ	0.001 kΩ	0.9 % + 1	
	60.00 kΩ	0.01 kΩ	0.9 % + 1	
⊕ <sup>[3]</sup>	1000 nF	1 nF	1.9 % + 2	
	10.00 μF	0.01 μF	1.9 % + 2	
	100.0 μF	0.1 μF	1.9 % + 2	
	9999 μF	1 μF	100 μF - 1000 μF: 1.9 % + 2 > 1000 μF: 5 % + 20	

- [1] All Ⓞ Chek voltage ranges are specified from 60 counts to 100 % of range. Because inputs below 60 counts are not specified, it is possible and normal for this and other true-rms meters to display non-zero readings when the test leads are disconnected from a circuit or are shorted together.
- [2] Crest factor of  $\leq 3$  at 4000 counts, decreasing linearly to 1.5 at full scale.
- [3] After measuring voltage, a wait time of 1 minute is required to maintain accuracy of ohms, capacitance, diode test, and continuity.

<b>Maximum Voltage Between any Terminal and Earth Ground:</b>	600 V
<b>Display:</b>	3 3/4-digits, 6000 counts, updates 4/sec
<b>Operating Temperature:</b>	-10°C to 50°C (14°F to 122°F)
<b>Storage Temperature:</b>	-40°C to 60°C (-22°F to 140°F)
<b>Temperature Coefficient:</b>	0.1 x (specified accuracy)/°C (<18 °C or >28 °C)
<b>Operating Altitude:</b>	2,000 m
<b>Storage Altitude:</b>	10,000 m
<b>Relative Humidity:</b>	95 % to 30 °C 75 % to 40 °C 45 % to 50 °C
<b>Battery Type:</b>	9 Volt Alkaline, ANSI 1604A / IEC 6F22
<b>Battery Life:</b>	Alkaline: 300 hours typical, without backlight
<b>Shock:</b>	1 Meter drop per IEC 61010-1-2001
<b>Vibration:</b>	Per MIL-PRF-28800 for Class 2 instrument
<b>Size (H x W x L):</b>	6.58 in X 3.35 in X 1.81 in (167.1 mm X 85.1 mm X 46.0 mm)
<b>Weight:</b>	13.0 oz (404 g)
<b>Safety:</b>	Complies with ANSI/ISA 82.02.01 (61010- 1) 2004, CAN/CSA-C22.2 No 61010-1-04, UL 61010-1 (2004) and IEC/EN 61010-1 2 <sup>nd</sup> Edition for measurement Category III, 600 V, Pollution Degree 2, EMC EN61326-1.

**EMI Regulations:** Complies with FCC Part 15, Class B

**Certifications:**



TUV, (N10140), UL and VDE

<b>Function</b>	<b>Input Impedance (Nominal)</b>	
☑ Chek	~3 k $\Omega$ <300 pF	
	<b>Common Mode Rejection Ratio (1 k<math>\Omega</math> Unbalanced)</b>	
☑ Chek	>60 dB at dc, 50 or 60 Hz	
	<b>Open Circuit Test Voltage</b>	<b>Full Scale Voltage</b>
$\Omega$	<2.7 V dc	<0.7 V dc
→	<2.7 V dc	2.000 V dc
	<b>Short Circuit Current</b>	
$\Omega$	<350 $\mu$ A	
→	<1.0 mA	

### ***MIN MAX Recording Accuracy and Response Time***

Specified accuracy of the measurement function  $\pm 40$  counts in ☑Chek for changes >500 ms in duration,  $\pm 12$  counts in Ohms for changes >325 ms in duration. Typical 100 ms response to 80 %. Response time not specified for Capacitance.



## LIMITED WARRANTY & LIMITATION OF LIABILITY

This Fluke product will be free from defects in material and workmanship for three years from the date of purchase. This warranty does not cover fuses, disposable batteries, or damage from accident, neglect, misuse, alteration, contamination, or abnormal conditions of operation or handling. Resellers are not authorized to extend any other warranty on Fluke's behalf. To obtain service during the warranty period, contact your nearest Fluke authorized service center to obtain return authorization information, then send the product to that Service Center with a description of the problem.

THIS WARRANTY IS YOUR ONLY REMEDY. NO OTHER WARRANTIES, SUCH AS FITNESS FOR A PARTICULAR PURPOSE, ARE EXPRESSED OR IMPLIED. FLUKE IS NOT LIABLE FOR ANY SPECIAL, INDIRECT, INCIDENTAL OR CONSEQUENTIAL DAMAGES OR LOSSES, ARISING FROM ANY CAUSE OR THEORY. Since some states or countries do not allow the exclusion or limitation of an implied warranty or of incidental or consequential damages, this limitation of liability may not apply to you.

Fluke Corporation  
P.O. Box 9090  
Everett, WA 98206-9090  
U.S.A.

Fluke Europe B.V.  
P.O. Box 1186  
5602 BD Eindhoven  
The Netherlands